

# Roth

**Roth Uhrenthermostat  
Basicline T**

**Roth Basicline T Timer**



**INSTALLATIONSHANDBUCH**

# Inhalt

## Inhalt

Lieferumfang  
Einleitung  
Produktkonformität  
Installation  
Bedienung  
Parametereinstellungen  
Anmerkungen des Installateurs  
Garantie

In dieser Anleitung verwendete Icons:



Sicherheit



Wichtige Information



Zu Ihrem Nutzen

Die neueste  
Installationsanleitung  
steht auf  
[www.roth-werke.de](http://www.roth-werke.de)  
zur Verfügung.

## Lieferumfang



1 x Installationshandbuch



Befestigungsschrauben



Basicline T

# Produktkonformität und Sicherheitsinformationen

## EINLEITUNG

Vielen Dank, dass Sie sich für das Raumthermostat Basicline T entschieden haben. Das Basicline T ist ein digitales 230 V Raumthermostat, das eine einfache Temperaturkontrolle Ihres Heizungssystems bietet.

Durch den Kauf des Raumthermostates haben Sie sich für ein digitales Raumthermostat entschieden, das es Ihnen erlaubt, Oberflächenheizungssysteme individuell einzustellen, wie Fußboden-, Wand- oder Flächenheizung. Sie können deutlich Energie sparen, indem die Temperatur gesenkt wird.



### Produktkonformität

Dieses Produkt ist CE-konform und erfüllt die folgenden EG-Richtlinien:  
Richtlinie 2004/108/EG für elektromagnetische Verträglichkeit  
Niederspannungsrichtlinie 2006/95/EG



### Sicherheitsinformation

Produkt muss gemäß der Richtlinien verwendet werden. Das Thermostat ist für die Raumsteuerung von Heizungs- und Warmwassersystemen in Innenräumen gedacht.



### Installation

Die Installation dieses Produktes muss durch eine sachkundige Person und im Einklang mit allen örtlich geltenden Anweisungen, Richtlinien und Bestimmungen erfolgen, die auf die Stadt, das Land oder das Bundesland, wo das Produkt installiert wird, zutreffen. Die Nichteinhaltung der entsprechenden Anweisungen, Richtlinien und Bestimmungen kann zu Verletzungen, Todesfällen oder Strafverfolgung führen.



Vor der Installation oder jeglichen Arbeiten an dem Gerät Spannungsversorgung abschalten.

Wir wünschen Ihnen viel Freude mit diesem Produkt.

# Produktkonformität und Sicherheitsinformationen



## Gefahrenquellen

Das Thermostat muss vom Strom getrennt werden, bevor die Abdeckung entfernt wird.



**230 V AC**



## Notfall

Stellen Sie die Stromzufuhr zur Klemmleiste des einzelnen Thermostats oder zum kompletten System ab.



## Installationsparametereinstellungen

Das Raumthermostat verfügt über einen Abschnitt zu den Installationsparametern. Diese dürfen nur vom Installateur oder einer sachkundigen Person geändert werden. Das Verändern dieser Parameter kann schwerwiegende Folgen für Ihr Heizungssystem haben, siehe Seite 41.



## Für den Installateur

Bitte tragen Sie jegliche Parameterveränderungen in das Formular 'Anmerkungen des Installateurs' ein.

# Installation - Anschluss

## Anschlüsse

Rückseite des Basicline T

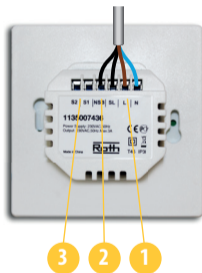

**Stromanschlüsse 230 VAC**  
Spannungsversorgung für  
Thermostat und geschalteten  
Ausgang.



**Anschluss NSB**  
**(Nachtabenkung)**  
Verwendet für 230 V Ausgang zu  
anderem Thermostat, siehe Seite 8.



**Sensoranschlüsse S1, S2**  
(Optional)  
Können für externen Luft-  
oder Bodensensor verwendet  
werden.

# Installation - Thermostatmontage



Vordere Abdeckung vorsichtig entriegeln.



Vordere Abdeckung vorsichtig entfernen.

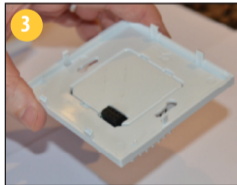

**i Wandmontage**  
Das Thermostat eignet sich für Unterputzdosen mit einem Lochabstand von: 60 mm.

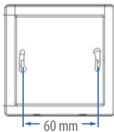

**i**  
Nur für Unterputzdosen mit horizontalen Befestigungslöchern

# Installation - Thermostatmontage



## Montageposition

Um fehlerfreien Betrieb und effiziente Steuerung sicherzustellen, sollte das Thermostat im besten Fall in einem zugluftfreien Bereich in etwa 130 cm Höhe angebracht werden. Bringen Sie das Thermostat nicht in der Nähe von Wärmequellen, hinter Gardinen, in direkter Sonneneinstrahlung oder in einem Bereich mit hoher Luftfeuchtigkeit an.

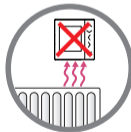
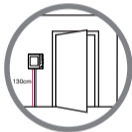

Gerät nicht an einer Außenwand montieren.



# Installation - Anschluss

Optionaler Sensor



NSB für andere Thermostate



Klemmleiste

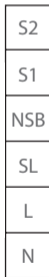

S2	Sensoranschluss (optional)
S1	Sensoranschluss (optional)
NSB	NSB-Ausgang (Nachtabsenkung)
SL	Last (Thermischer Stellantrieb)
L	Stromführend 230 VAC 50 Hz
N	Nullleiter

Ausgang

Thermischer Stellantrieb



L N

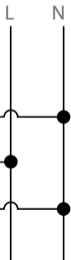

# Installation - Anschluss



Überprüfen Sie, ob die Verdrahtung für folgende Anschlüsse komplett ist:

- 1 Stromanschluss
- 2 Anschluss für NSB (Nachtabsenkung)
- 3 Sensoranschlüsse (falls zutreffend)

Das hintere Gehäuse kann nun befestigt werden.



Bitte verwenden Sie die mitgelieferten Schrauben.



Stellen Sie sicher, dass der Ausrichtungspfeil nach oben zeigt.



## Anbringung der Gehäusefront an das hintere Gehäuse



Stellen Sie sicher, dass die Steckverbindungen aufeinander sitzen.



Richten Sie das vordere Gehäuse an der oberen Kante aus.



**1** Gehäusefront an der oberen Kante ansetzen.







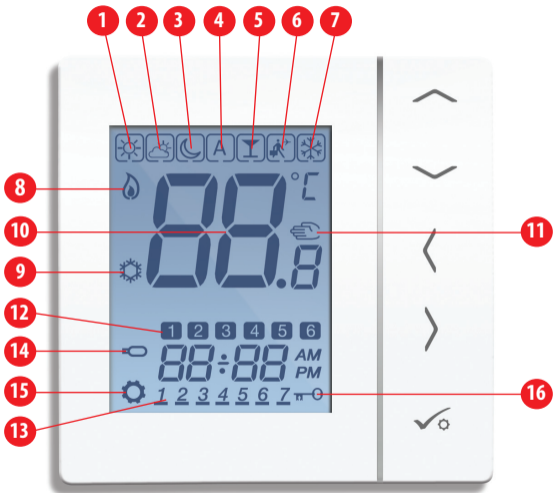





**2** Vorsichtig drücken, bis die Front mit einem "Klick" einrastet.





# Installation - Display Symbole



# Installation - Display Symbole



SYMBOL	FUNKTION	
	<b>BOX</b> bedeutet Auswählen des Modus z. B.  bedeutet, dass derzeit "Hohe Temperatur" gewählt ist,  bedeutet, dass "Hohe Temperatur" nicht gewählt ist.	
	<b>Sonnig:</b> Hohe komfortable Temperatur.	1
	<b>Bewölkt:</b> Mittlere komfortable Temperatur.	2
	<b>Mond:</b> Niedrige komfortable Temperatur.	3
	<b>Programmanzeige Programmierbarer Thermostat:</b> Zeigt an, ob ein Programm in Betrieb ist, Auto Ein oder Auto Aus.	4
	<b>Partyanzeige:</b> Wenn die Partyfunktion aktiv ist.	5
	<b>Urlaubsanzeige:</b> Wenn die Urlaubsfunktion aktiv ist.	6
	<b>Frostschutzanzeige:</b> Frostschutz ist aktiv - nicht verfügbar im Kühlmodus (falls zutreffend).	7

# Installation - Display Symbole

SYMBOL	FUNKTION	
	<b>Wärmebedarf:</b> Zeigt an, dass Wärme benötigt wird.	8
	<b>Kühlmodusanzeige:</b> Zeigt an, dass Kühlung benötigt wird (falls zutreffend).	9
	<b>Temperaturanzeige:</b> Zeigt die Raumtemperatur an. Zeigt die eingestellte Temperatur an. Zeigt zudem andere Informationen an.	10
	<b>Anzeige für temporäre manuelle Temperaturanpassung:</b> Falls die Temperatur im Programmmodus geändert wird, erscheint die Hand bis zum Start der nächsten Programmzeit.	11
	<b>Anzeige Programmnummer:</b> Im Programmmodus AUTO bedeutet dies den Betrieb des aktuellen Programms.	12
	<b>Tagesanzeige:</b> 1 = Montag	13



## Installation - Display Symbole

SYMBOL	FUNKTION	
	<b>Anzeige Bodensensor:</b> Wird nur angezeigt, wenn Luft- oder Bodensensor angeschlossen ist.	14
	<b>Anzeige Einstellung:</b> Zeigt an, dass die Einheit im Einstellmodus ist, bei Programmeinstellung. Zeigt den manuellen Modus an.	15
	<b>Anzeige Tastensperre:</b> Zeigt an, dass Tasten gesperrt sind.	16

# Installation - Benutzeroberfläche

TASTE	FUNKTION
 ODER 	1. Temperatureinstellwert verringern oder erhöhen. 2. Tag, Uhr, Timer, Party, und Urlaub verringern oder erhöhen. 3. Installationsparameterwert auswählen.
 ODER 	1. Modusauswahl. 2. Lange gedrückt halten, um ohne Speichern zum Startbildschirm zurückzukehren. 3. Kurz gedrückt halten, um zum vorherigen Bildschirm zurückzukehren - in Benutzer-/Installationseinstellmodus.
	1. OK-Taste: kurz gedrückt halten, um Auswahl zu bestätigen. 2. Lange gedrückt halten, um zu speichern und zu beenden. 3. Lange gedrückt halten, um Benutzereinstellungen aufzurufen.
 5 SEKUNDEN	Tastensperre aktivieren/deaktivieren.
 5 SEKUNDEN	Parametermenü aufrufen.



# Installation - erstmaliges Einschalten

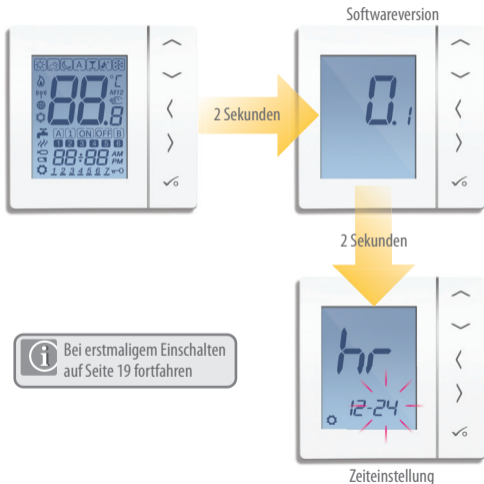

 Bei erstmaligem Einschalten auf Seite 19 fortfahren

# Installation - Symbolerklärung



Einmalig drücken



X-mal drücken



Für fünf Sekunden gedrückt halten



Blinken



Kurz gedrückt halten,  
um zurückzukehren. <



Kurz drücken, um zu speichern und  
lange drücken, um zu speichern  
und Menü zu verlassen. ✓ ⚙



## Bedienung - Zeit und Datum einstellen

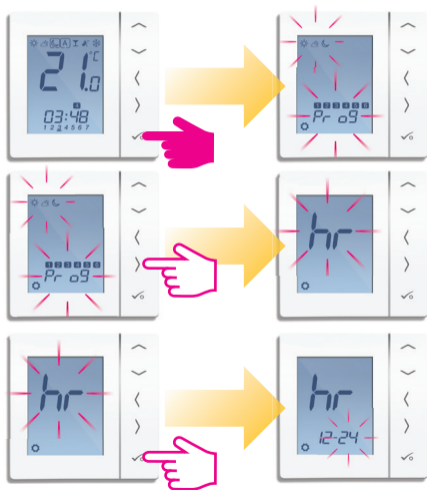

## Bedienung - Zeit und Datum einstellen



Links auswählen für  
12-Stunden, rechts  
auswählen für  
24-Stunden

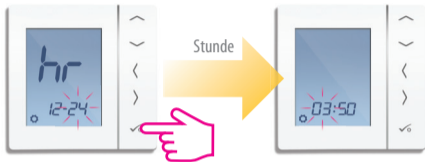

Zeit einstellen  
mithilfe der nach  
oben/nach unten  
Taste.

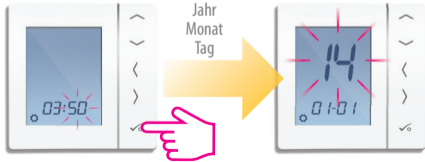

## Bedienung - Temperaturlevel Heizung



Höchste Temperatur wird normalerweise für frühen Morgen und frühen Abend verwendet.  
**Normalerweise 21 °C**



Mittlere Temperatur wird normalerweise während des Tages verwendet, wenn Sie zuhause aktiv sind  
**Normalerweise 19 °C**



Niedrigere Temperatur wird normalerweise für unbenutzte Räume oder während der Nacht verwendet.  
**Normalerweise 17 °C für Fußbodenheizung oder 15 °C für Radiatorheizung.**



Frostschutztemperatur wird normalerweise während langer Abwesenheit oder des Urlaubs verwendet.  
**Normalerweise 5 °C**



Ihr Thermostat ist auf die oben erwähnten Temperaturen voreingestellt. Sie können angepasst werden (siehe Seite 37).

## Bedienung - Temperaturlevel Kühlung



Siehe Parametermenü D18, Abschnitt auf Seite 44



Temperatur bei Anwesenheit. Normalerweise 22 °C



Temperatur bei Abwesenheit. Normalerweise 40 °C  
Dies verhindert die Aktivierung der Kühlung bei Abwesenheit.



Abendtemperatur. Normalerweise 26 °C



Ihr Thermostat ist auf die oben erwähnten Temperaturen voreingestellt.  
Sie können angepasst werden (siehe Seite 37).



# Bedienung - Zeitprogramm Heizen 1

Werkseitig aktiviert

Montag bis Freitag

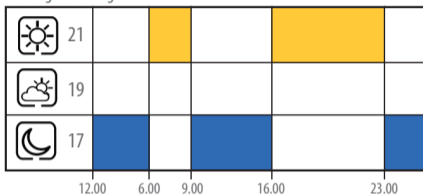

Samstag bis Sonntag

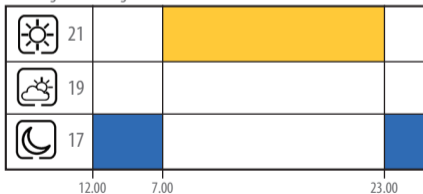









## Bedienung - Zeitprogramm Kühlbetrieb 1 (werkseitig)

Montag bis Freitag

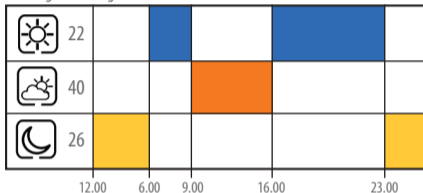

Samstag bis Sonntag

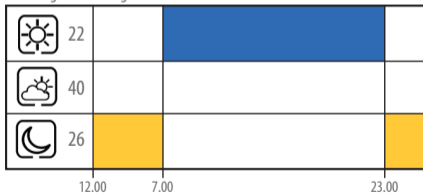









## Bedienung - Zeitprogramm einstellen



Links und rechts verwenden, um den Tag der Programme auszuwählen.

5/2

1 2 3 4 5 6 7

7 Tage

1 2 3 4 5 6 7

Individuell

1 2 3 4 5 6 7

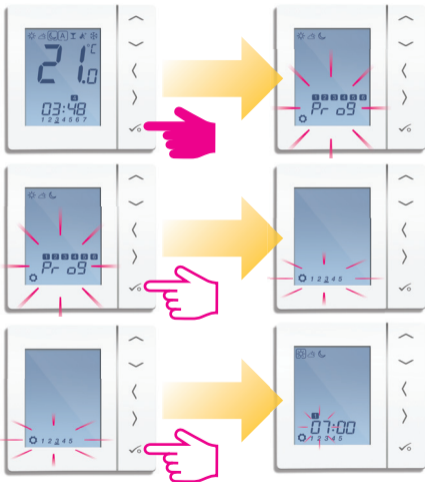

## Bedienung - Zeitprogramm einstellen



Zeit einstellen  
mithilfe der nach  
oben/nach unten  
Taste.



Rechts und links  
verwenden, um  
die hohe,  
mittlere oder  
niedrige  
Temperatur zu  
wählen.



## Bedienung - Zeitprogramm einstellen



Bis zu Schaltpunkt 4 wiederholen.  
Falls ein 5. oder 6. Schaltpunkt benötigt wird, Zeit eingeben und Temperatur    auswählen.



Um einen Schaltpunkt zu löschen, Zeit auf --:-- einstellen.



Wenn die    Temperatur eingestellt wird, übernimmt das Zeitprogramm die neuen Temperaturen - siehe Seite 37 zur Änderung von   

## Bedienung - Temporäre Temperaturanpassung



Verwenden Sie die obere oder untere Pfeiltaste, um die von Ihnen eingestellte Programmtemperatur einzusehen.



Die temporäre Temperaturanpassung erlaubt es Ihnen, die Soll-Temperatur auf die gewünschte Einstellung zu erhöhen oder zu verringern, bis sie beim nächsten Programmpunkt zurückgesetzt wird.



Verwenden Sie die obere oder untere Pfeiltaste, um die Temperatur auf die gewünschte Einstellung anzupassen.



## Bedienung - Temporäre Temperaturanpassung





Um die temporäre Anpassung zu beenden, (< oder >) drücken (siehe unten).

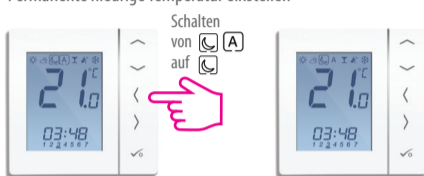

# Bedienung - Dauerhafte Temperaturänderung

Permanente niedrige Temperatur einstellen



 Verwenden Sie die obere oder untere Pfeiltaste, um die von Ihnen eingestellte Temperatur einzusehen, siehe Seite 35.



Zurück auf Automatikbetrieb  **A** schalten.

Für



wiederholen, falls nötig.



## Bedienung - Partyfunktion



Durch die Partyfunktion kann die  Temperatur für einen von Ihnen gewählten Zeitraum eingestellt werden (bis zu 9 h 50 min).



Rechte Pfeiltaste verwenden, um Partyfunktion auszuwählen.



Obere Pfeiltaste verwenden, um h/min auszuwählen.



Häkchen klicken und Countdown beginnt.



## Bedienung - Urlaubsfunktion



## Bedienungshandbuch - Frostschutz



# Installation - Parametermenü öffnen



**i** Falls Sie die Geräteparameter ändern müssen, befolgen Sie die folgenden Schritte.



**i** Muss durch den Installateur erfolgen.



**i** Dies ist der erste Bildschirm des Gerätemenüs.



# Installation - Geräteparameter

DX	FUNKTION	SYSTEMEINSTELLUNG	DEFINITION	STANDARD
D01	Heizungs- regelung	0	Pulsweitenmodulation	0
		1	Ein-Aus 0,5 °C +/- 0,25 °C	
		2	Ein-Aus 1,0 °C +/- 0,5 °C	
D02	Temperaturfühler Korrektur	-3,0 bis 3,0 °C	Temperatur-Offset der gemessenen Temperatur zur Kompensierung von Fehlern	0 °C
D03	Anschluss externer Sensor	0	Sensor nicht angeschlossen	0
		1	Sensor angeschlossen	
D04	Sensor Funktion: Verwendet als Luft- oder Bodensensor	0	D03 muss auf 1 eingestellt werden, dann Verwendung als Luftsensord. Es erfolgt keine interne Temperaturmessung	0
		1	D03 muss auf 1 eingestellt werden, dann wird externer Sensor für Bodenschutz verwendet. Interne Temperatur gemessen von Thermostat	
D05	Kühlungssteuerung	1	Ein-Aus 0,5 °C +/- 0,25 °C	2
		2	Ein-Aus 1,0 °C +/- 0,5 °C	
D06	Stellantriebart	0	NO Normal offen	1
		1	NC Normal geschlossen	
D07	Ventilschutz- funktion	0	Deaktivieren	1
		1	Aktivieren	

# Installation - Geräteparameter

DX	FUNKTION	SYSTEMEINSTELLUNG	DEFINITION	STANDARD
D08	Frost Grenzwert-Temperatur	5-17 °C	Benötigte Temperatur für Frostschutz und Urlaubsfunktion	5 °C
D09	Stunden-Format	0	12 Stunden	1
		1	24 Stunden	
D10	nicht verfügbar	nicht verfügbar	nicht	nicht verfügbar
D11	Sommerzeit	0	AUS	1
		1	EIN	
D12	Heizung Grenzwert	5-35 °C	Maximale Temperatur, die für Heizung eingestellt werden kann	35 °C
D13	Kühlung Grenzwert	5-40 °C	Maximale Temperatur, die für Kühlung eingestellt werden kann	5 °C
D14	Bodensensor oberer Grenzwert	6-45 °C	Ausgangsrelais schaltet sich aus, wenn Temperatur für Bodenschutz erreicht wird	27 °C
D15	Bodensensor unterer Grenzwert	6-45 °C	Ausgangsrelais schaltet sich ein, wenn Temperatur für Bodenschutz erreicht wird	10 °C
D16	Bodensensor-Limit für Kühlung	6-45 °C	Ausgangsrelais schaltet sich aus, wenn Temperatur für Bodenschutz erreicht wird	6 °C

# Installation - Geräteparameter

DX	FUNKTION	SYSTEMEINSTELLUNG	DEFINITION	STANDARD
D17	Programmauswahl voreinstellen	1-5	1-5 der Standardprogramme auswählen	1
D18	Heiz-/Kühlmodus auswählen	0 oder 1	0: Heizmodus 1: Kühlmodus	0

Auf Werkseinstellungen zurücksetzen

Alle drei Tasten gleichzeitig drücken.

Nummer 47 eingeben und drücken

Muss durch den Installateur erfolgen.

FEHLERCODE	FEHLERBESCHREIBUNG
Err02	Maximale/Minimale Fußbodentemperatur überschritten
Err03	Verbindung zum externen Sensor unterbrochen
Err04	Kurzschluss externer Sensor

## Installation - Technische Daten

<b>Model</b>	Uhrenthermostat Basicline T 230 V
<b>Art</b>	Elektronisch programmierbares digitales Raumthermostat, entwickelt für 230 VAC Anwendungen
<b>Programmierarten</b>	Frei wählbar: 5/2, ALLE und individuelle Tagesoptionen
<b>Zeitprogramme</b>	5 individuelle Programme mit maximal 6 Schaltpunkten
<b>Funktionen</b>	Party, Urlaub, Zeitprogramm und Frostschutz
<b>Nachtabsenkung</b>	230 V Ausgang
<b>Temperatureinstellung</b>	Permanent und temporär
<b>Frostschutz</b>	5 °C anpassbar
<b>Spannungsversorgung</b>	230 V AC 50Hz
<b>Ausgänge LS, NSB</b>	230 V AC/max. 3A
<b>Einstellbereich</b>	5 bis 35 °C, Toleranz 0,5 °C
<b>Heizen / Kühlen</b>	Über Parametermenü wählbar
<b>Sensor</b>	Luft oder Bodenschutz
<b>Geräteparameter</b>	Siehe Seite 42 für vollständige Liste der Funktionen
<b>Betriebstemperatur</b>	0 bis 50 °C
<b>Lagertemperatur</b>	-20 bis 60 °C





## Garantie

Roth garantiert, dass das hier beschriebene Produkt frei von Material- oder Verarbeitungsfehlern ist und seinen Zweck im Rahmen seiner Spezifikation für einen Zeitraum von zwei Jahren ab Installationsdatum erfüllen wird. Die alleinige Gewährleistungshaftung von Roth besteht darin (nach eigener Wahl), das defekte Produkt zu reparieren oder zu ersetzen.

Kundenname: .....

Kundenadresse: .....

..... Postleitzahl: .....

Tel: ..... E-Mail: .....

Installationsunternehmen: .....

Tel: ..... E-Mail: .....

Installationsdatum: .....

Name des Monteurs: .....

Unterschrift des Monteurs: .....



Baseline T

# Roth

Roth Basicline T Timer



INSTALLER MANUAL

# Contents

## Contents

Box Contents  
Introduction  
Product Compliance  
Installation  
User Guide  
Parameter Settings  
Installers Notes  
Warranty

## Icons used in this manual:



Safety



Important info



Your benefit

For latest PDF installation  
guide please go to  
[www.roth-werke.de](http://www.roth-werke.de)

## Box Contents



1 x User manual



Fixing screws



Basicline T

# Product Compliance & Safety Information

## INTRODUCTION

Thank you for purchasing the Roth room thermostat Basicline T. The Basicline T is a 230 V digital thermostat which offers simple temperature control of your heating system.

By purchasing the room thermostat you have decided on a digital room thermostat which allows you to adjust surface heating appliances individually, such as underfloor, wall or panel heating. A clear energy saving is possible by reducing temp.



## Product Compliance

This product is CE compliant and meets the following EC Directives Electro-Magnetic Compatibility Directive 2004/108/EC Low voltage Directive 2006/95/EC



## Safety Information

Use in accordance with the regulations. The room thermostat is to be used for room control of hot water heating systems inside the house.



## Installation

This product must be fitted by a competent person, and installation must comply with the guidance, standards and regulations applicable to the city, country or state where the product is installed. Failure to comply with the requirements of the relevant guidance, standards and regulations could lead to injury, death or prosecution.



Always isolate the AC mains supply before installing or working on any components that require 230 V AC 50 Hz supply.



We hope you enjoy this product...

## Product Compliance & Safety Information



### Sources of danger

The thermostat must be disconnected from mains supply before removing the cover.



**230 V AC**



### Emergency

Switch off the voltage to the individual thermostat wiring centre or complete system.



### Installer parameter settings

The room thermostat is equipped with installer parameter section. This must only be entered by the installer or competent person. Changing these parameters can have a serious effect on your heating system. See page 89.



### For the installer

Please enter any parameter changes in the installer notes section.

# Installation – Terminal Connections

## Understanding your terminal connections

Rear of Baseline T

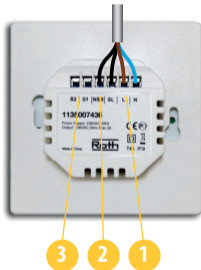

### 1 Power Terminals 230 Vac

Used for supplying power to the unit and switched output.



### 2 NSB (Night Set Back) Connection

Used for a 230 V output to other thermostat. See page 56.



### 3 Sensor Terminals S1, S2 (Optional)

Can be used for external AIR or Floor sensor.

## Installation – Thermostat Mounting



Gently remove front housing.



Gently remove front housing.

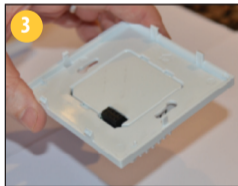

### Wall Mounting

For wall mounting, mark and mount the rear case to the wall. The room thermostat is suitable for wall boxes with a centre hole distance of : 60 mm

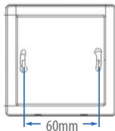

Only for flush mounting boxes with horizontal fixing holes.

## Installation – Thermostat Mounting



### Mounting position and installation

To ensure trouble free operation and efficient control, the room thermostat is best positioned in a draft free area, and at 130 cm from the floor. Do not position the thermostat near any heat source, behind curtains, direct sunlight or an area of high humidity.

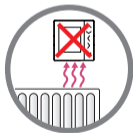
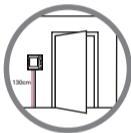

Not to be positioned on an exterior wall.



# Installation – Terminal Connections

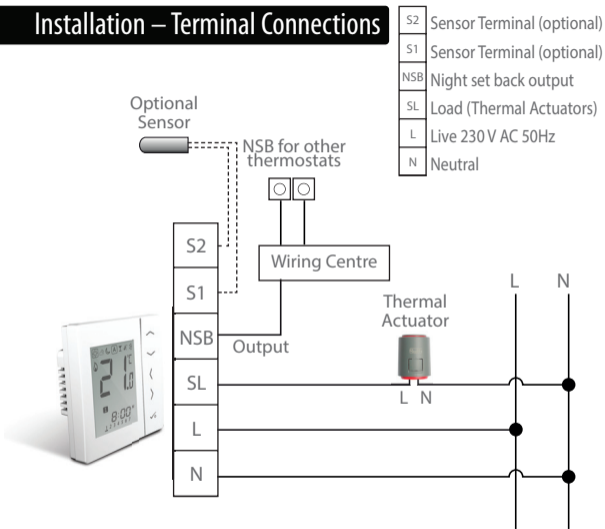

## Installation – Terminal Connections



Check that the wiring is completed for:

- 1 Power Terminals
- 2 NSB (Night Set Back) Connection
- 3 Sensor Terminals (if applicable)

You are ready to secure the rear housing to the wall box



Please use the screws provided



Ensure the orientation arrow is pointing upwards.



## Installation – Thermostat Mounting



Fit the front housing to the rear housing



Ensure the pin connections are aligned



1

Align the front housing at the top edge.









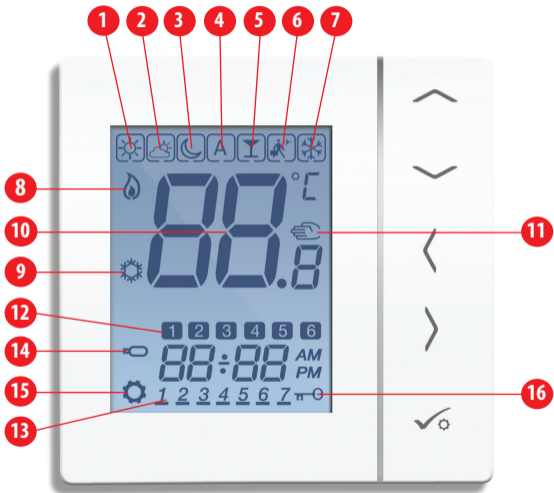



2

Lightly press until you hear a positive click.







# Installation – LCD Graphics



## Installation – LCD Graphics



SYMBOL	FUNKTION	
	<b>BOX</b> means to select the mode e.g.  means the current setpoint is Hi temp,  means the Hi temp is not selected.	
	<b>Sunny:</b> Hi comfortable temperature.	1
	<b>Cloudy:</b> Middle comfortable temperature.	2
	<b>Moon:</b> Low comfortable temperature.	3
	<b>Programmable thermostat Program mode indicator:</b> Indicates program is running, Auto On or Auto Off.	4
	<b>Party indicator:</b> When Party mode is active.	5
	<b>Vacation indicator:</b> When Vacation mode is active.	6
	<b>Frost protection indicator:</b> Frost protection is active, not available in cooling mode (if applicable).	7

# Installation – LCD Graphics







ICON	FUNCTION	
	<b>Heat indicator:</b> Indicates heat is required.	8
	<b>Cool mode indicator:</b> Indicates cooling is required (if applicable).	9
	<b>Temperature indicator:</b> Display the room temperature. Display the set-temp. Also used to show the other information.	10
	<b>Temporary manual override indicator:</b> If the set temperature is changed when in program mode, the hand will appear until the next program start time.	11
	<b>Programs number indicator:</b> In AUTO program mode or Temporary override is running, it means the current program running.	12
	<b>Day indication:</b> 1 = Monday.	13



## Installation – User Interface

ICON	FUNCTION	
	<b>Floor sensor probe indicator:</b> Show only when Air + Floor sensor is connected.	14
	<b>Setting indicator:</b> Indicates the unit is in setting mode when program setting. Indicates the manual mode.	15
	<b>Keylock indicator:</b> Shows that keys are inactive.	16

# Installation – User Interface

KEY	FUNCTION
 OR 	<ol style="list-style-type: none"> <li>1. Increase or decrease setpoint temperature.</li> <li>2. Increase or decrease Day, Clock, Timer, Party and Holiday.</li> <li>3. Select installer parameter value.</li> </ol>
 OR 	<ol style="list-style-type: none"> <li>1. Mode selection.</li> <li>2. Long press to return to home display without saving.</li> <li>3. Short press to return to the previous screen when it is in user /installer setting mode.</li> </ol>
	<ol style="list-style-type: none"> <li>1. OK key: Short press to confirm selection.</li> <li>2. Long press to save and exit.</li> <li>3. Long press to enter the user settings.</li> </ol>
 5 SECONDS	Lock/Unlock.
 5 SECONDS	Enter Installer parameter settings.



# Installation – First Power Up

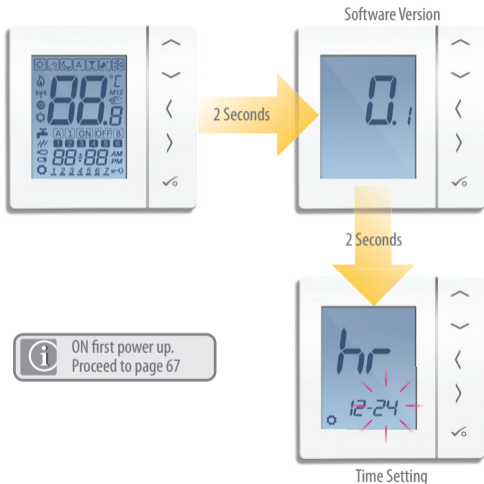

ON first power up.  
Proceed to page 67

# Installation - Graphics Key



Press once



Press x amount of times



Hold for five seconds



Flashing



Short press to back up



Short press to save and  
long press to save and exit



## User Guide - Setting time and date

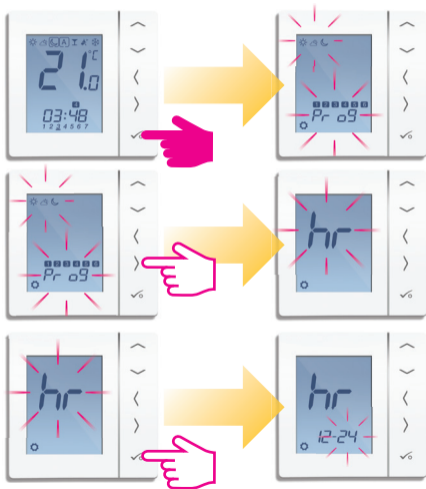

## User Guide - Setting time and date



Use left to select 12 hour and right to select 24 hour.

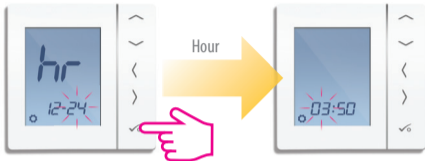

Adjust the time using the up or down arrow key.



## User Guide – Understanding Temperature Levels - Heating



Highest Temperature typically used for early morning and early evening.

**Typically 20 Deg C**



Mid Temperature typically used for times of day when you are active around the home.

**Typically 19 Deg C**



Lower Temperature typically used for unoccupied or sleep times.

**Typically 17 Deg C for UFH or 15 Deg C for radiators**



Frost Temperature typically used for periods of long absence or holidays.

**Typically 5 Deg C**



Your thermostat comes preset for the above temperatures. These can be adjusted. Please see page 85.

## User Guide - Understanding Temperature Levels - Cooling



See device setting D18, section on page 92



Occupied Temperature. Typically 22 °C



Unoccupied Temperature Typically 40 °C  
This avoids cooling being active when the property is unoccupied.



Evening Temperature Typically 26 °C



Your thermostat comes preset for the above temperatures. These can be adjusted. Please see page 85.



## User Guide - Default Heating Schedule 1

Monday to Friday

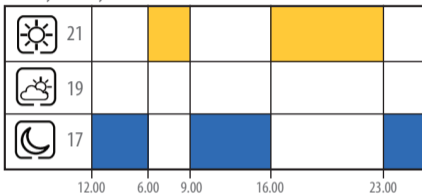

Saturday to Sunday

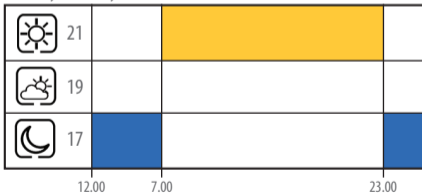



## User Guide - Optional Heating Schedule 3

Monday to Friday

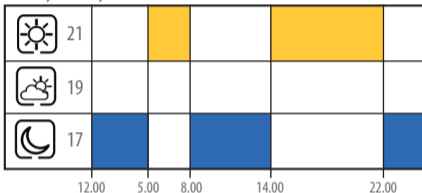

Saturday to Sunday

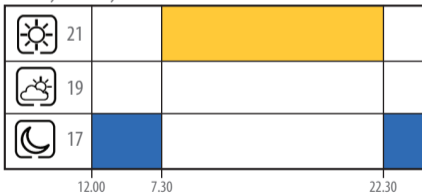



## User Guide - Optional Heating Schedule 5

Monday to Friday

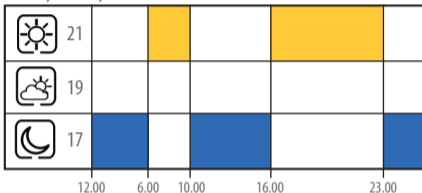

Saturday to Sunday

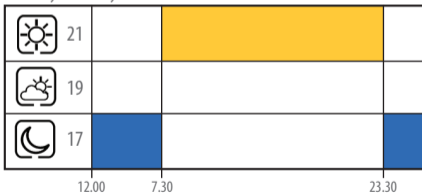

# User Guide - Default Cooling Schedule 1

Monday to Friday

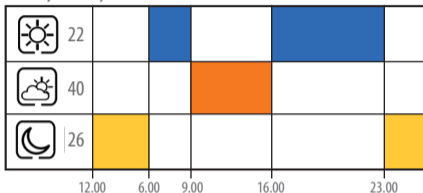

Saturday to Sunday

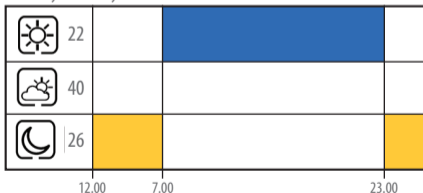









## User Guide – Setting the Temperature Schedule

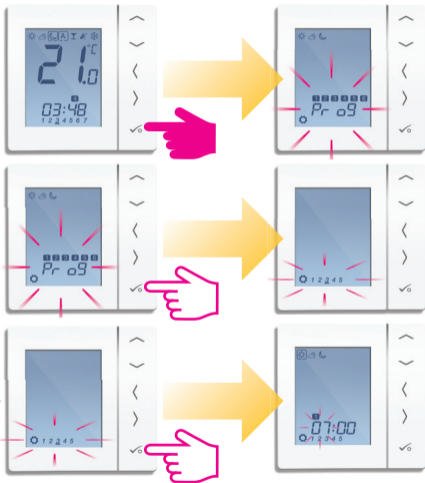

Use right and left to select the day of the programs.

5/2

1 2 3 4 5 6 7

7 Days

1 2 3 4 5 6 7

Individual

1 2 3 4 5 6 7

## User Guide – Setting the Temperature Schedule



Adjust the time using the up or down arrow key.



Use right and left to select the Hi/Mid or low temp.

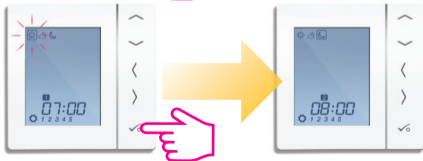

## User Guide – Setting the Temperature Schedule



Repeat through to program 4.  
If you require a 5th or 6th program enter a time  
and select your temperature ☀️ ☁️ 🌙



To remove a program out set the time to --:--.



When you set the ☀️ ☁️ 🌙 temperature, the schedule will respond to those temperatures. See page 85 on how to change ☀️ ☁️ 🌙

## User Guide - Temporary Override



Use the up or down arrow key to view your program set temperature.



Temporary override allows you to increase the temperature or decrease it to the desired setting until it reverts back on the next program time.



Use the up or down arrow key to adjust the temperature to the setting you desire.



## User Guide - Temporary Override

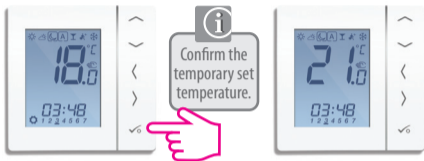

 To cancel temporary override press < or >  
See below.



## User Guide - Permanent Override

### Setting permanent low temperature

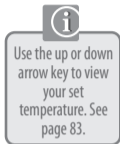
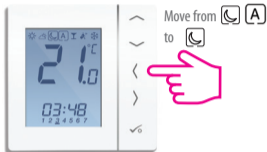

Repeat for



if required



## User Guide - Party Mode



The party mode is an option that enables  temperature for a period of time. You select up to 9hr 50min.



Use the right arrow to select the party mode.



Use the up arrow to select the hr/min.



Press tick to confirm and it will start to count down .



## User Guide - Holiday Mode

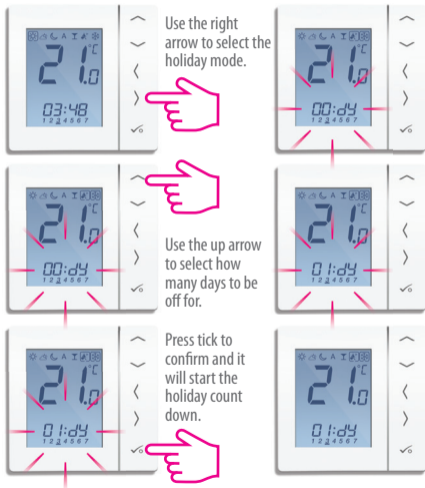

## User Guide - Frost Protection



# Installation - Entering Device Menu

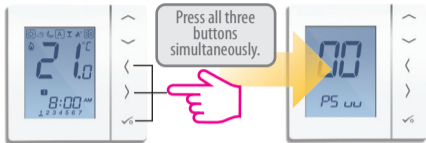

**i**  
If you need to change device parameters follow the steps below.



**i**  
Must only be entered by the installer.



**i**  
This is the first screen of the device menu.

## Installation - Device Parameters

DX	FUNCTION	SYSTEM SETTING	DEFINITION	DEFAULT
D01	Heating Control	0	Pulse Width Modulation	0
		1	On-Off 0.5 Deg C +/- 0.25 Deg C	
		2	On-Off 1.0 Deg C +/- 0.5 Deg C	
D02	Room Temperature Offset	-3.0 to 3.0 Deg C	Temperature Offset from Measured Temperature to Compensate for any error	0 Deg C
D03	Sensor probe or Cylinder thermostat connection	0	Sensor stat not Connected	0
		1	Sensor stat Connected	
D04	Sensor probe used as air sensor or floor sensor	0	D03 must be set to 1 then external sensor be used as Air sensor. There will be no internal temp measurement	0
		1	D03 must be set to 1 then external sensor used for floor protection. Internal temp is measured by stat	
D05	Cooling Control	1	On-Off 0.5 Deg C +/- 0.25 Deg C	2
		2	On-Off 1.0 Deg C +/- 0.5 Deg C	
D06	Actuator type	0	NO Normally Open	1
		1	NC Normally Closed	
D07	Valve protection	0	Disable	1
		1	Enable	

# Installation - Device Parameters

DX	FUNCTION	SYSTEM SETTING	DEFINITION	DEFAULT
D08	Frost Set point Temperature	5-17 Deg C	Required Temperature for frost protection and holiday mode	5 Deg C
D09	Hour Format	0	12	1
		1	24	
D10	N/A	N/A	N/A	N/A
D11	Daylight Saving Time (DST)	0	OFF	1
		1	ON	
D12	Heating Set point Limit	5-35 Deg C	Maximum temp that can be set for heating	35 Deg C
D13	Cooling Set point Limit	5-40 Deg C	Maximum temp that can be set for Cooling	5 Deg C
D14	Floor sensor High Limit Temperature	6-45 Deg C	Output relay will be switched off when temp is reached for floor protection	27 Deg C
D15	Floor sensor Low Limit Temperature	6-45 Deg C	Output relay will be switched on when temp is reached for floor protection	10 Deg C
D16	Floor sensor Limit for cooling	6-45 Deg C	Output relay will be switched off when temp is reached for floor protection	6 Deg C



## Installation - Device Parameters

DX	FUNCTION	SYSTEM SETTING	DEFINITION	DEFAULT
D17	Preset program selection	1-5	Select 1-5 of the default programs	1
D18	Heat/Cool mode selection	0 or 1	0: heating mode 1: cooling mode	0

Reset to factory settings

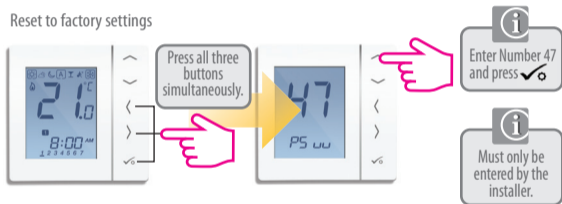

ERROR CODE	ERROR DESCRIPTION
Err02	Maximum/Minimum Floor Temp Reached
Err03	Broken Floor Sensor
Err04	Floor Sensor Short Circuit

## Installation - Technical Detail

<b>Model</b>	Thermostat Baseline T 230 V
<b>Type</b>	Electronic programmable room thermostat, digital room thermostat designed for 230 V AC applications
<b>Programming Modes</b>	User selectable for 5/2, ALL and Individual day options
<b>Program Number</b>	1-6 Selectable
<b>Modes</b>	Party, Vacation, Program and Frost
<b>NSB</b>	230 V Output
<b>Override</b>	Permanent and temporary
<b>Frost Protection</b>	5 °C Adjustable
<b>Power Source</b>	230 V AC 50Hz
<b>Rating</b>	230 V AC/max. 3A
<b>Temperature Scale</b>	5 to 35 °C, tolerance 0.5 °C
<b>Heat/Cool</b>	Local changeover
<b>Sensor</b>	Air or floor protection.
<b>Device Parameters</b>	See page 90 for full list of functions
<b>Operating Temperature</b>	0 to 50 °C
<b>Storage Temperature</b>	-20 to 60 °C





## Warranty

Roth warrants that this product will be free from any defect in materials or workmanship, and shall perform in accordance with its specification, for a period of two years from the date of installation. Roth sole liability for breach of this warranty will be (at its option) to repair or replace the defective product.

Customer Name: .....

Customer Address: .....

..... Post Code: .....

Tel No: ..... E-mail: .....

Engineers Company: .....

Tel No: ..... E-mail: .....

Installation Date: .....

Engineers Name: .....

Engineers Signature: .....





# Roth Energie- und Sanitärsysteme

## Roth energy and sanitary systems

### **ROTH WERKE GMBH**

Am Seerain 2

35232 Dautphetal

Telefon: +49 (0) 6466/922-0

Telefax: +49 (0) 6466/922-100

Technischer Support: +49 (0) 6466/922-266

E-Mail: [service@roth-werke.de](mailto:service@roth-werke.de)

[www.roth-werke.de](http://www.roth-werke.de)

